

Schottky Barrier Rectifier

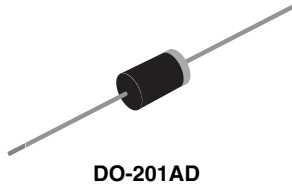

FEATURES

- Guardring for overvoltage protection
- Very small conduction losses
- Extremely fast switching
- Low forward voltage drop
- High frequency operation
- Solder dip 260 °C, 40 s
- Component in accordance to RoHS 2002/95/EC and WEEE 2002/96/EC



RoHS
COMPLIANT

TYPICAL APPLICATIONS

For use in low voltage high frequency inverters, freewheeling, dc-to-dc converters, and polarity protection applications.

MECHANICAL DATA

Case: DO-201AD

Epoxy meets UL 94V-0 flammability rating

Terminals: Matte tin plated leads, solderable per J-STD-002 and JESD22-B102

E3 suffix for consumer grade, meets JESD 201 class 1A whisker test

Polarity: Color band denotes the cathode end

PRIMARY CHARACTERISTICS	
$I_{F(AV)}$	5.0 A
V_{RRM}	20 V to 60 V
I_{FSM}	150 A
V_F	0.50 V, 0.70 V
$T_J \text{ max.}$	150 °C

MAXIMUM RATINGS ($T_A = 25\text{ °C}$ unless otherwise noted)							
PARAMETER	SYMBOL	SB520A	SB530A	SB540A	SB550A	SB560A	UNIT
Maximum repetitive peak reverse voltage	V_{RRM}	20	30	40	50	60	V
Maximum RMS voltage	V_{RMS}	14	21	28	35	42	V
Maximum DC blocking voltage	V_{DC}	20	30	40	50	60	V
Maximum average forward rectified current 0.375" (9.5 mm) lead length (Fig. 1)	$I_{F(AV)}$	5.0					A
Peak forward surge current, 8.3 ms single half sine-wave superimposed on rated load	I_{FSM}	150					A
Operating junction temperature range	T_J	- 65 to + 150					°C
Storage temperature range	T_{STG}	- 65 to + 150					°C

ELECTRICAL CHARACTERISTICS ($T_A = 25\text{ °C}$ unless otherwise noted)								
PARAMETER	TEST CONDITIONS	SYMBOL	SB520A	SB530A	SB540A	SB550A	SB560A	UNIT
Maximum instantaneous forward voltage ⁽¹⁾	5.0 A	V_F	0.50			0.70		V
Maximum reverse current at rated V_R ⁽²⁾	$T_A = 25\text{ °C}$	I_R	0.5					mA
	$T_A = 100\text{ °C}$		50		25			

Notes:

(1) Pulse test: 300 μ s pulse width, 1 % duty cycle

(2) Pulse test: Pulse width \leq 40 ms



THERMAL CHARACTERISTICS ($T_A = 25\text{ }^\circ\text{C}$ unless otherwise noted)							
PARAMETER	SYMBOL	SB520A	SB530A	SB540A	SB550A	SB560A	UNIT
Typical thermal resistance ⁽¹⁾	$R_{\theta JA}$			25			$^\circ\text{C/W}$
	$R_{\theta JC}$			10			
	$R_{\theta JL}$			8			

Note:

(1) Thermal resistance from junction to lead vertical P.C.B. mounting, 0.375" (9.5 mm) lead length

ORDERING INFORMATION (Example)				
PREFERRED P/N	UNIT WEIGHT (g)	PREFERRED PACKAGE CODE	BASE QUANTITY	DELIVERY MODE
SB540A-E3/54	1.08	54	1400	13" diameter paper tape and reel
SB540A-E3/73	1.08	73	1000	Ammo pack packaging

RATINGS AND CHARACTERISTICS CURVES

($T_A = 25\text{ }^\circ\text{C}$ unless otherwise noted)

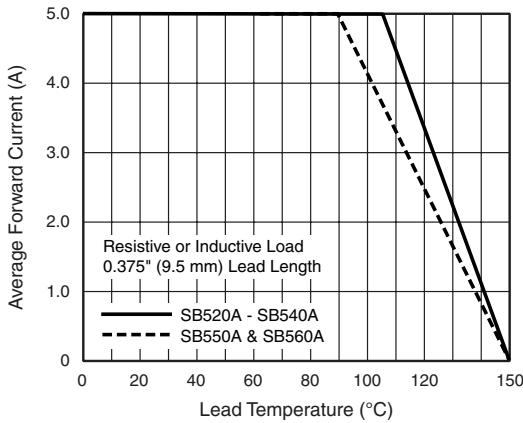

Figure 1. Forward Current Derating Curve

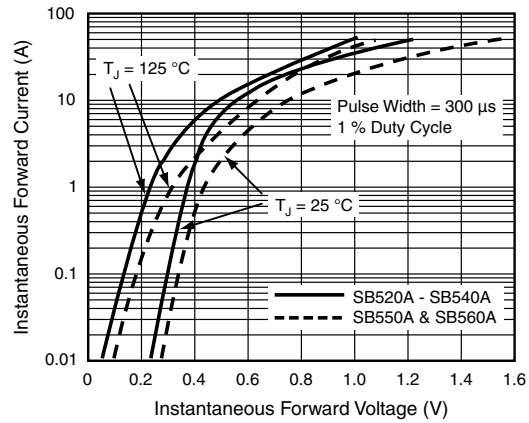

Figure 3. Typical Instantaneous Forward Characteristics

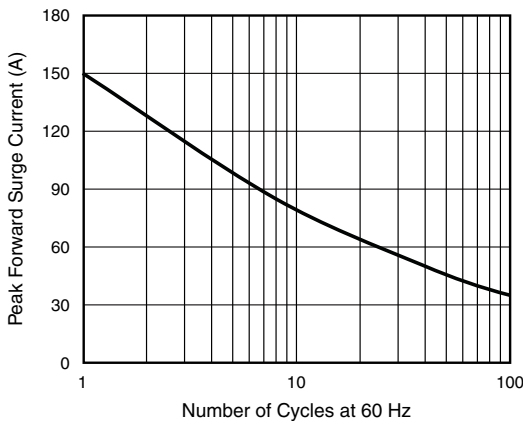

Figure 2. Maximum Non-Repetitive Peak Forward Surge Current

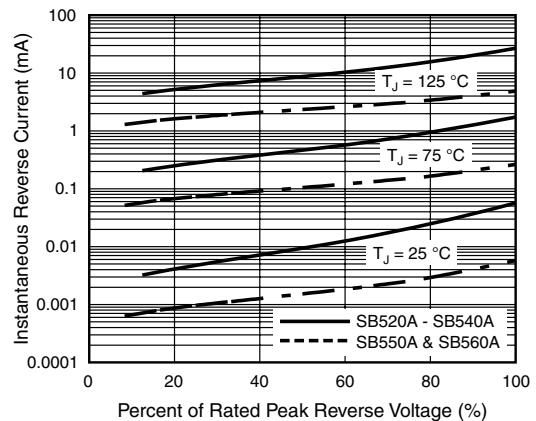

Figure 4. Typical Reverse Characteristics

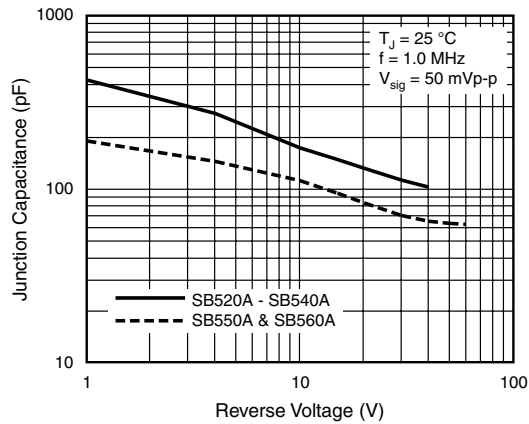

Figure 5. Typical Junction Capacitance

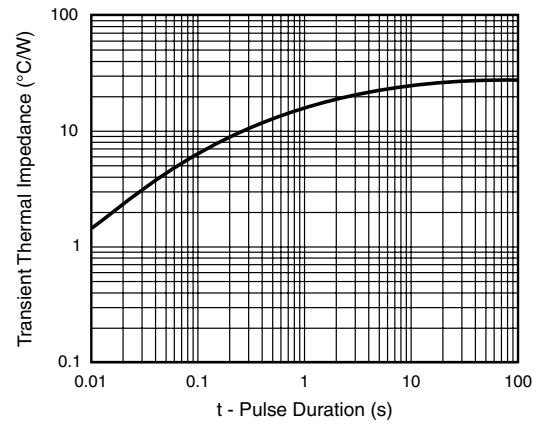
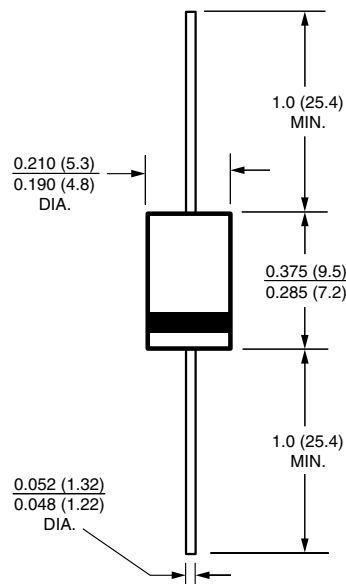

Figure 6. Typical Transient Thermal Impedance

PACKAGE OUTLINE DIMENSIONS in inches (millimeters)

DO-201AD





Disclaimer

All product specifications and data are subject to change without notice.

Vishay Intertechnology, Inc., its affiliates, agents, and employees, and all persons acting on its or their behalf (collectively, "Vishay"), disclaim any and all liability for any errors, inaccuracies or incompleteness contained herein or in any other disclosure relating to any product.

Vishay disclaims any and all liability arising out of the use or application of any product described herein or of any information provided herein to the maximum extent permitted by law. The product specifications do not expand or otherwise modify Vishay's terms and conditions of purchase, including but not limited to the warranty expressed therein, which apply to these products.

No license, express or implied, by estoppel or otherwise, to any intellectual property rights is granted by this document or by any conduct of Vishay.

The products shown herein are not designed for use in medical, life-saving, or life-sustaining applications unless otherwise expressly indicated. Customers using or selling Vishay products not expressly indicated for use in such applications do so entirely at their own risk and agree to fully indemnify Vishay for any damages arising or resulting from such use or sale. Please contact authorized Vishay personnel to obtain written terms and conditions regarding products designed for such applications.

Product names and markings noted herein may be trademarks of their respective owners.